

**Part Number: PT908-33195-02**

**Kit Contents**

Item #	Quantity Req.	Description
1	1	Cargo Tray

**Hardware Bag Contents**

Item #	Quantity Req.	Description

**Additional Items Required For Installation**

Item #	Quantity Req.	Description

**Conflicts**

None
------

**Recommended Tools**

<b>Personal &amp; Vehicle Protection</b>	<b>Notes</b>
Cover or blanket	
<b>Special Tools</b>	<b>Notes</b>
None	
<b>Installation Tools</b>	<b>Notes</b>
None	
<b>Special Chemicals</b>	<b>Notes</b>
None	

**General Applicability**

MY19 and newer ES/ESh vehicles
--------------------------------

**Recommended Sequence of Application**







Item #	Accessory
1	Cargo Tray
2	Cargo Net

\*Mandatory

**Vehicle Service Parts** (may be required for reassembly)

Item #	Quantity Req.	Description

**Legend**

	<b>STOP:</b> Damage to the vehicle may occur. Do not proceed until process has been complied with.
	<b>OPERATOR SAFETY:</b> Use caution to avoid risk of injury.
	<b>CAUTION:</b> A process that must be carefully observed in order to reduce the risk of damage to the accessory/vehicle and to ensure a quality installation.
	<b>TOOLS &amp; EQUIPMENT:</b> Used in Figures calls out the specific tools and equipment recommended for this process.
	<b>REVISION MARK:</b> This mark highlights a change in installation with respect to previous issue.
	<b>SAFETY TORQUE:</b> This mark indicates that torque is related to safety.

Care must be taken when installing this accessory to ensure damage does not occur to the vehicle. The installation of this accessory should follow approved guidelines to ensure a quality installation.

These guidelines can be found in the "Accessory Installation Practices" document.

This document covers such items as:-

- Vehicle Protection (use of covers and blankets, cleaning chemicals, etc.).
- Safety (eye protection, rechecking torque procedure, etc.).
- Vehicle Disassembly/Reassembly (panel removal, part storage, etc.).
- Electrical Component Disassembly/Reassembly (battery disconnection, connector removal, etc.).

Please see your Toyota dealer for a copy of this document.

### **1. Prepare for the Installation.**

- (a) Open the package and check the part for damage and kit contents.
- (b) Remove any stored items and debris from trunk area.
-  (c) Place vehicle protection over the trunk and rear bumper.

### **2. Install the Cargo Tray.**

- (a) Place the cargo tray in the trunk area with the logo towards the rear of the vehicle and facing up (Fig 2-1).

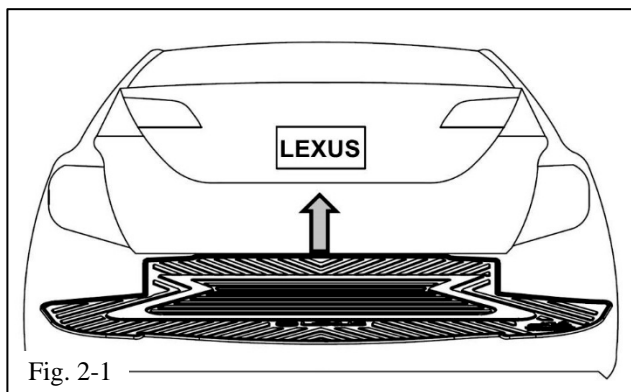
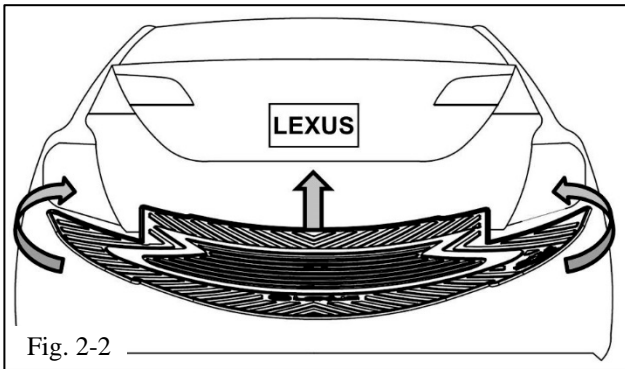

Fig. 2-1



- ⚠ (b) Grasp the tray by the sides and fold up and inward sufficiently to slide it into the rear compartment.
- (c) After installing the tray, ensure all the edges are pushed down against the floor (Fig 2-2).

**3. Complete the Installation.**

- (a) Remove the vehicle protection.
- (b) Close the trunk door.

Checklist - these points **MUST** be checked to ensure a quality installation.

Check:

Look For:

Accessory Function Checks

- Correct part number has been installed

Verify part number on package.

Vehicle Function Checks

- 
- 
- 

Vehicle Appearance Check

- After accessory installation and removal of protective cover(s), perform a visual inspection.

Ensure no damage (including scuffs and scratches) was caused during the installation process.  
(For PPO installations, refer to TMS Accessory Quality Shipping Standard.)